



Product Data Sheet

LPMM-7-27-24-58

Low profile MiMo LTE & cellular antenna
with MiMo WiFi

| C/Note | Doc Issue | Date | Approval |
|--------|-----------|------------|----------|
| 01019 | 1 | 06.06.2013 | J.J. |

PANORAMA  ANTENNAS

LTE MIMO Antenna

Low Profile MIMO Antenna



LPMM-7-27-24-58

Rugged low profile design

2x Wideband LTE/cellular elements

2x 2.4 & 4.9-6GHz WiFi/WIMAX Elements

The Panorama LPMM low profile MIMO antenna range has been designed to support the new generation of vehicular LTE routers.

The antenna enclosure contains four isolated high performance antenna elements; two ultra-wideband elements covering 698-2700MHz support MIMO/diversity at cellular/LTE frequencies and two dual band elements covering 2.3-2.7 & 4.9-6GHz support MIMO/diversity operation for WiFi and WiMAX.

The antenna does not require a metallic ground plane, and maintains a high level of performance even when mounted on a non-metallic surface.

Technical Drawing

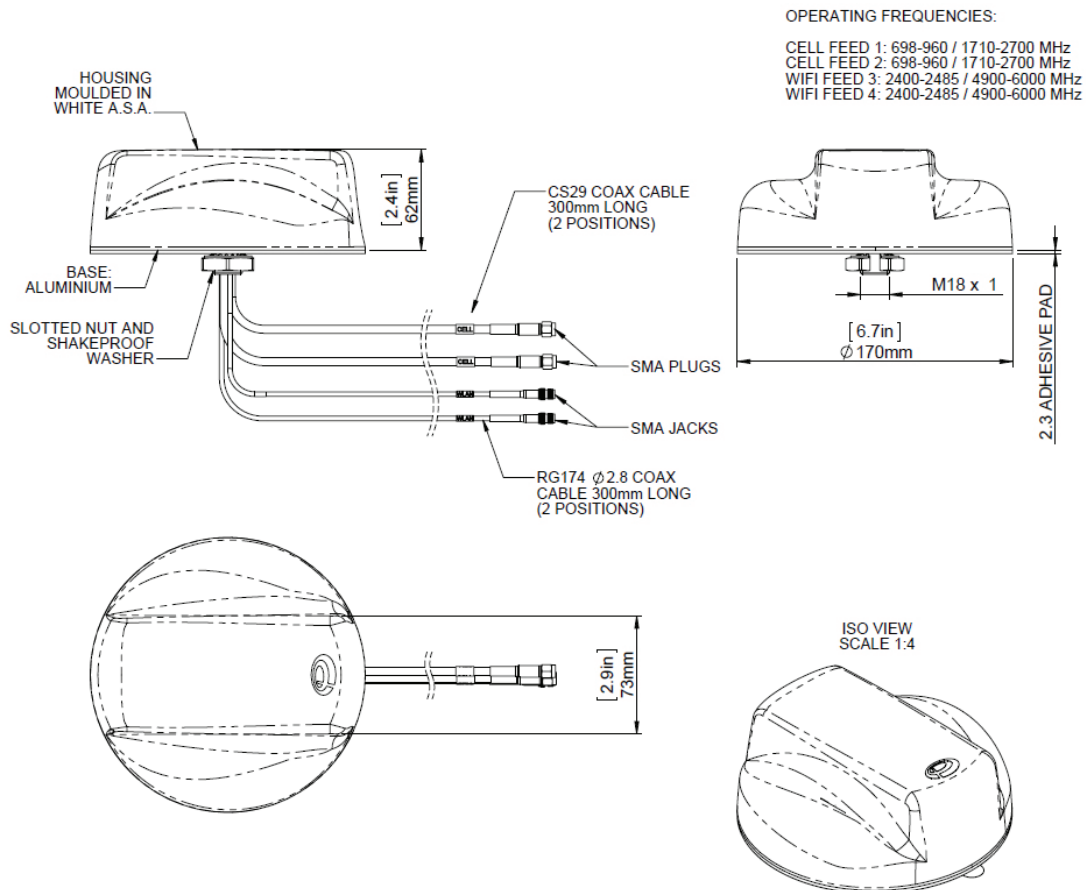

LTE MIMO Antenna

Low Profile MIMO Antenna

| | | |
|---------------------------|---------------------------|-----------------------------|
| Part No. | | LPMM-7-27-24-58 |
| Electrical Data | | |
| Frequency Range (MHz) | Elements 1 & 2 | 698-960 / 1700-2700 |
| | Elements 3 & 4 | 2.3-2.7 / 4.9-6GHz |
| Operational Bands | Elements 1 & 2 | LTE / Cellular |
| | Elements 3 & 4 | WIFI / WIMAX |
| Peak Gain: Isotropic | Elements 1 & 2 -698-960 | 2.3dBi |
| | Elements 1 & 2 -1700-2700 | 5dBi |
| | Elements 3 & 4 | 2dBi |
| VSWR | Elements 1 & 2 | < 2.5:1 |
| | Elements 3 & 4 | < 2:1 |
| Isolation (in free space) | Elements 1 & 2 | > 15dB |
| | Elements 3 & 4 | > 20dB |
| Polarisation | | Vertical |
| Impedance | | 50Ω |
| Max Input Power (W) | | 50 |
| Mechanical Data | | |
| Dimensions | Height | 2.4" (62mm) |
| | Diameter | 6.7" (170mm) |
| Operating Temp | | -22° / 176°F (-30° / +80°C) |
| Material | | A.S.A & diecast aluminium |
| Colour | | White |
| Mounting Data | | |
| Mounting type | | Panel mount |
| Max panel thickness | | 0.236"(6mm) |
| Mounting hole | | 3/4" (19mm) |
| Cable Data | | |
| Cell / LTE Cables x2 | Type | CS29 (double shielded RG58) |
| | Diameter | 0.2"(5mm) |
| | Length | 1' (0.3m) |
| | Termination | SMA (male) |
| WIFI / WiMAX Cables x2 | Type | RG174 |
| | Diameter | 0.11" (2.8mm) |
| | Length | 1' (0.3m) |
| | Termination | SMA (female) |

We recommend the customer uses Panorama C29 type coax for LTE and C32 type coax WLAN.

LTE MIMO Antenna

Low Profile MIMO Antenna

Typical VSWR cellular / LTE elements*

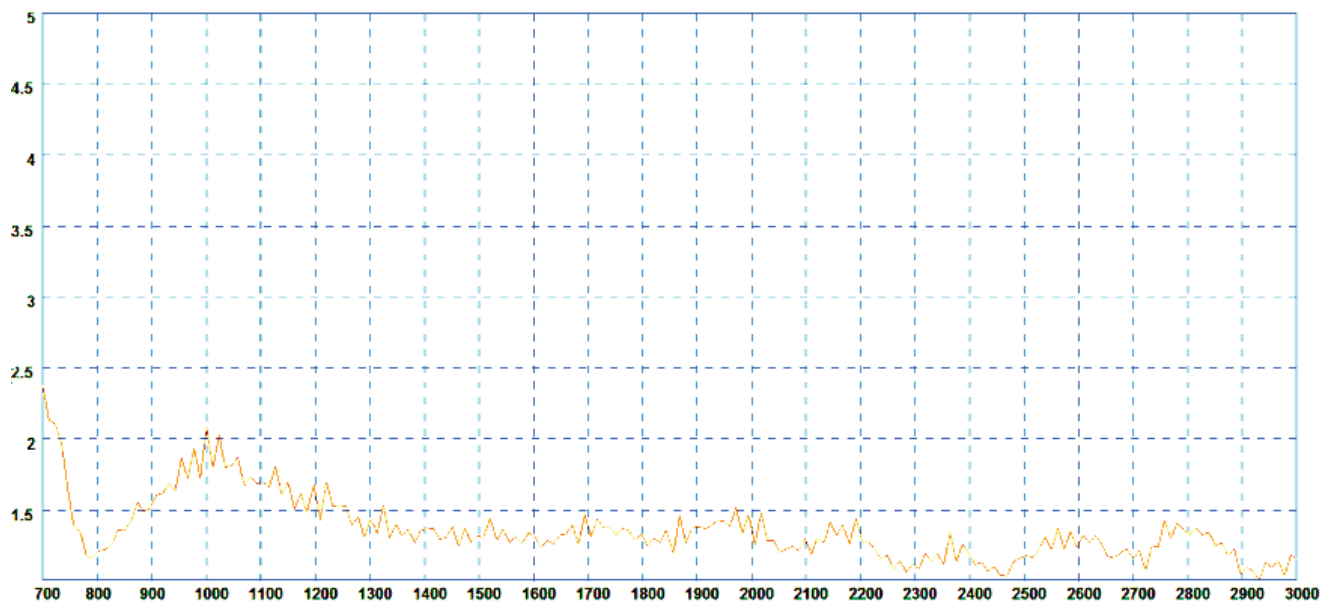

* VSWR measured in free space with 4.5m (15') of CS29 cable.

Typical VSWR WIFI elements 2.4GHz*

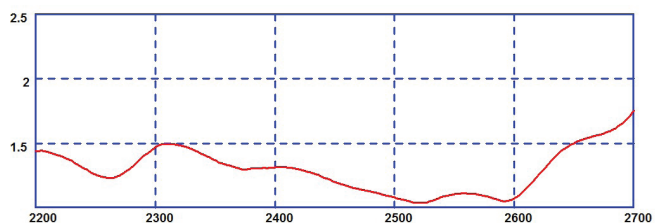

Typical VSWR WIFI elements 5GHz*

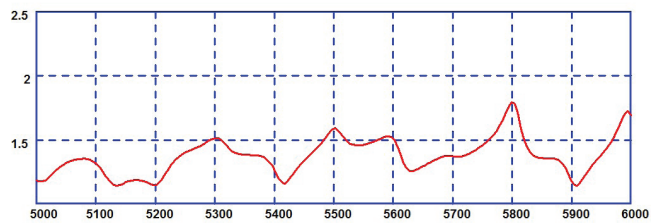

* VSWR measured with 5m (17') of cable.

Typical Isolation cellular / LTE elements*

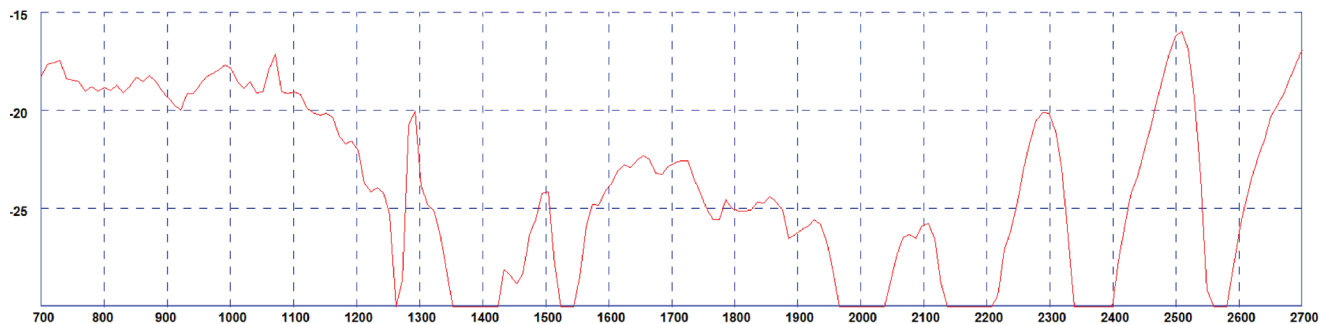

* Isolation measured in free space with 300mm (1') of cable.

LTE MIMO Antenna

Low Profile MIMO Antenna

Typical 3D Pattern - Elements 1&2 700MHz

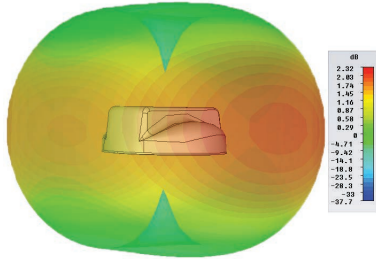

Typical 3D Pattern - Elements 1&2 800MHz

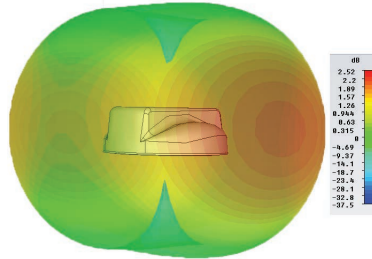

Typical 3D Pattern - Elements 1&2 900MHz

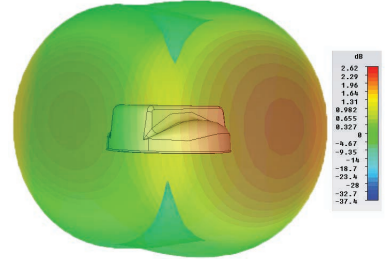

Typical 3D Pattern - Elements 1&2 1800MHz

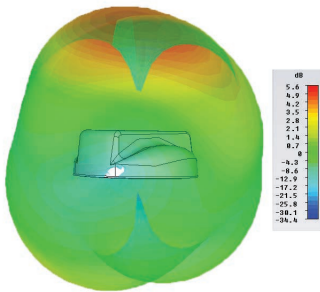

Typical 3D Pattern - Elements 1&2 1900MHz

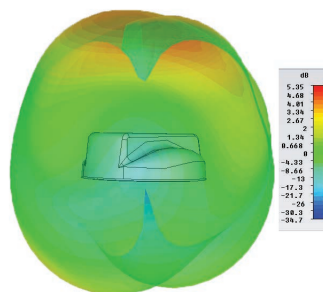

Typical 3D Pattern - Elements 1&2 2100MHz

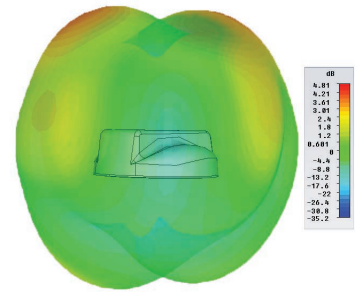

Typical 3D Pattern - Elements 1&2 2400MHz

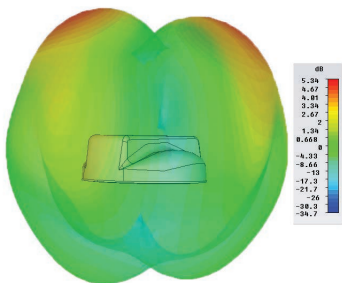

Typical 3D Pattern - Elements 1&2 2500MHz

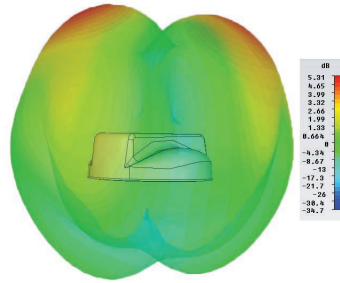

Typical 3D Pattern - Elements 1&2 2600MHz

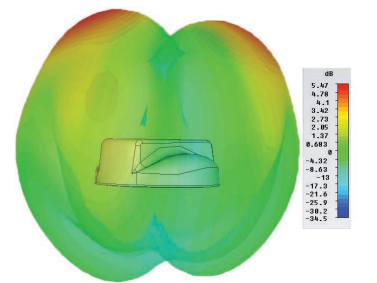

Typical H-Plane - Element 3 2450 MHz

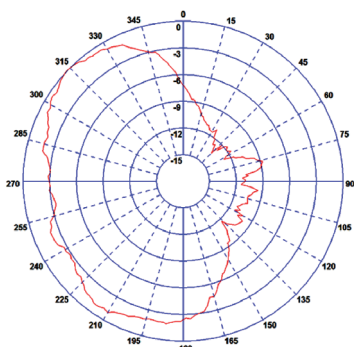

Typical H-Plane - Element 4 2450MHz

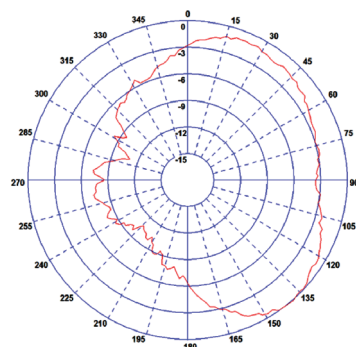

N.B. All pattern and gain measurements taken in free space without additional ground plane.

Panorama Antennas Ltd

Frogmore, London, SW18 1HF, United Kingdom

T: +44 (0)20 8877 4444

F: +44 (0)20 8877 4477

E: sales@panorama-antennas.com

www.panorama-antennas.com

Waiver: The data given above is indicative of the performance of the product/s under particular conditions and does not imply a guarantee of performance. These specifications are subject to change without notice.

Copyright © Panorama Antennas Ltd. All rights reserved.

